

FCC Test Report

Report No.: FD191225C13

Test Model: EXBC-1100

Series Model: EXBC-1XXXXXXXXXXXXX ("X" can be 0-9, A-Z or blank for marketing purpose)

Received Date: Jul. 17, 2019

Test Date: Jul. 23 ~ Jul. 24, 2019

Issued Date: Dec. 30, 2019

Applicant: Vecow Co., Ltd.

Address: 12F, No.111, Zhongcheng Rd., Tucheng Dist., New Taipei City 236, Taiwan

Issued By: Bureau Veritas Consumer Products Services (H.K.) Ltd., Taoyuan Branch
Lin Kou Laboratories

Lab Address: No. 47-2, 14th Ling, Chia Pau Vil., Lin Kou Dist., New Taipei City, Taiwan

Test Location: No. 19, Hwa Ya 2nd Rd., Wen Hwa Vil., Kwei Shan Dist., Taoyuan City
33383, TAIWAN

**FCC Registration /
Designation Number:** 328930 / TW1050



This report is for your exclusive use. Any copying or replication of this report to or for any other person or entity, or use of our name or trademark, is permitted only with our prior written permission. This report sets forth our findings solely with respect to the test samples identified herein. The results set forth in this report are not indicative or representative of the quality or characteristics of the lot from which a test sample was taken or any similar or identical product unless specifically and expressly noted. Our report includes all of the tests requested by you and the results thereof based upon the information that you provided to us. You have 60 days from date of issuance of this report to notify us of any material error or omission caused by our negligence, provided, however, that such notice shall be in writing and shall specifically address the issue you wish to raise. A failure to raise such issue within the prescribed time shall constitute your unqualified acceptance of the completeness of this report, the tests conducted and the correctness of the report contents. Unless specific mention, the uncertainty of measurement has been explicitly taken into account to declare the compliance or non-compliance to the specification. The report must not be used by the client to claim product certification, approval, or endorsement by A2LA or any agency of the U.S. Government. The report must not be used by the client to claim product certification, approval, or endorsement by TAF or any government agencies.

Table of Contents

Release Control Record	3
1 Certificate of Conformity	4
2 Summary of Test Results.....	5
2.1 Measurement Uncertainty	5
2.2 Modification Record	5
3 General Information	6
3.1 General Description of EUT	6
3.2 Features of EUT	6
3.3 Operating Modes of EUT and Determination of Worst Case Operating Mode	6
3.4 Test Program Used and Operation Descriptions.....	7
3.5 Primary Clock Frequencies of Internal Source	7
4 Configuration and Connections with EUT	8
4.1 Connection Diagram of EUT and Peripheral Devices	8
4.2 Configuration of Peripheral Devices and Cable Connections	9
5 Conducted Emissions at Mains Ports.....	10
5.1 Limits	10
5.2 Test Instruments	10
5.3 Test Arrangement	11
5.4 Test Results.....	12
6 Radiated Emissions up to 1 GHz	14
6.1 Limits	14
6.2 Test Instruments	15
6.3 Test Arrangement	16
6.4 Test Results.....	17
7 Radiated Emissions above 1 GHz.....	19
7.1 Limits	19
7.2 Test Instruments	20
7.3 Test Arrangement	21
7.4 Test Results.....	22
8 Pictures of Test Arrangements	26
8.1 Conducted Emissions at Mains Ports	26
8.2 Radiated Emissions up to 1 GHz	27
8.3 Radiated Emissions above 1 GHz	28
Appendix – Information of the Testing Laboratories	29

Release Control Record

Issue No.	Description	Date Issued
FD191225C13	Original Release	Dec. 30, 2019

1 Certificate of Conformity

Product: Motherboard
Brand: Vecow
Test Model: EXBC-1100
Series Model: EXBC-1XXXXXXXXXXXXX ("X" can be 0-9, A-Z or blank for marketing purpose)
Sample Status: Identical Prototype
Applicant: Vecow Co., Ltd.
Test Date: Jul. 23 ~ Jul. 24, 2019
Standards: 47 CFR FCC Part 15, Subpart B, Class A
ICES-003:2016 Issue 6, updated Apr. 2019, Class A
ANSI C63.4:2014

The above equipment has been tested by **Bureau Veritas Consumer Products Services (H.K.) Ltd., Taoyuan Branch**, and found compliance with the requirement of the above standards. The test record, data evaluation & Equipment Under Test (EUT) configurations represented herein are true and accurate accounts of the measurements of the sample's EMC characteristics under the conditions specified in this report.

Prepared by :  _____, Date: _____ Dec. 30, 2019
Lena Wang / Specialist

Approved by :  _____, Date: _____ Dec. 30, 2019
Carl Chen / Project Engineer

2 Summary of Test Results

47 CFR FCC Part 15, Subpart B / ICES-003:2016 Issue 6, updated Apr. 2019, Class A
 ANSI C63.4:2014

FCC Clause	ICES-003 Clause	Test Item	Result/Remarks	Verdict
15.107	6.1	AC Power Line Conducted Emissions	Minimum passing Class A margin is -18.96 dB at 8.79900 MHz	Pass
15.109	6.2.1	Radiated Emissions up to 1 GHz	Minimum passing Class A margin is -1.73 dB at 615.99 MHz	Pass
	6.2.2	Radiated Emissions above 1 GHz	Minimum passing Class A margin is -9.05 dB at 1386.01 MHz	Pass

Note:

1. There is no deviation to the applied test methods and requirements covered by the scope of this report.
2. Determining compliance based on the results of the compliance measurement, not taking into account measurement instrumentation uncertainty.

2.1 Measurement Uncertainty

Where relevant, the following measurement uncertainty levels have been estimated for tests performed on the EUT:

Measurement	Frequency	Expanded Uncertainty (k=2) (\pm)
Conducted Emissions at mains ports	150 kHz ~ 30 MHz	2.79 dB
Radiated Emissions up to 1 GHz	30 MHz ~ 1 GHz	4.14 dB
Radiated Emissions above 1 GHz	Above 1 GHz	5.04 dB

2.2 Modification Record

There were no modifications required for compliance.

3 General Information

3.1 General Description of EUT

Product	Motherboard
Brand	Vecow
Test Model	EXBC-1100
Series Model	EXBC-1XXXXXXXXXXXXX ("X" can be 0-9, A-Z or blank for marketing purpose)
Status of EUT	Identical Prototype
Operating Software	Windows 10
Power Supply Rating	24 Vdc (Adapter)
Accessory Device	N/A
Data Cable Supplied	N/A

Note:

1. The EUT is authorized for use in specific End-product.

Product	Brand	Model
High Performance System	Vecow	SPC-5600A

2. All models are listed as below.

Brand	Model	Difference
Vecow	EXBC-1100	All models are electrically identical, different model names are for marketing purpose.
	EXBC-1XXXXXXXXXXXXX ("X" can be 0-9, A-Z or blank for marketing purpose)	

3. The End-product contains following accessory devices.

Product	Brand	Model	Description
Adapter	Meanwell	GST160A24_R7B (160W)	I/P: 100-240 Vac, 50/60 Hz, 2 A O/P: 24 Vdc, 6.67 A, 160W Max. 1.2 m non-shielded cable with core
CPU	Intel	I7-8700	3.2GHz
SSD	Innodisk	3MG2-P	64G
DDR4	DSL	D4SN1G081SH26B-CI	8GB

3.2 Features of EUT

The tests reported herein were performed according to the method specified by Vecow Co., Ltd., for detailed feature description, please refer to the manufacturer's specifications or user's manual.

3.3 Operating Modes of EUT and Determination of Worst Case Operating Mode

Test modes are presented in the report as below.

Mode	Test Condition
Conducted Emission	
1	LAN Link + Switch with cable + USB with M/S + USB with K/B + USB with HDD*2 + RS232 Terminal + Mic+Earphone + DP with Monitor*2 + DVI-I with Monitor + Adapter
Radiated Emission	
1	LAN Link + Switch with cable + USB with M/S + USB with K/B + USB with HDD*2 + RS232 Terminal + Mic+Earphone + DP with Monitor*2 + DVI-I with Monitor + Adapter

3.4 Test Program Used and Operation Descriptions

- a. The EUT installed into High Performance System and placed on the testing table.
- b. The EUT was charged from adapter via High Performance System.
- c. The High Performance System linked with Notebooks via LAN cables.
- d. The High Performance System sent audio signal to the earphone.
- e. The High Performance System linked with Monitors via DP and DVI cables.
- f. The High Performance System read and wrote data with HDDs.
- g. The High Performance System linked with Keyboard and Mouse via USB Cable.
- h. The High Performance System linked with Terminals, I/O Cable and GND Cable.
- i. The EUT communicated data with the Notebooks, which acted as communication partners.

3.5 Primary Clock Frequencies of Internal Source

The highest frequency generated or used within the EUT or on which the EUT operates or tunes is 3700 MHz, provided by Vecow Co., Ltd., for detailed internal source, please refer to the manufacturer's specifications.

4 Configuration and Connections with EUT

4.1 Connection Diagram of EUT and Peripheral Devices

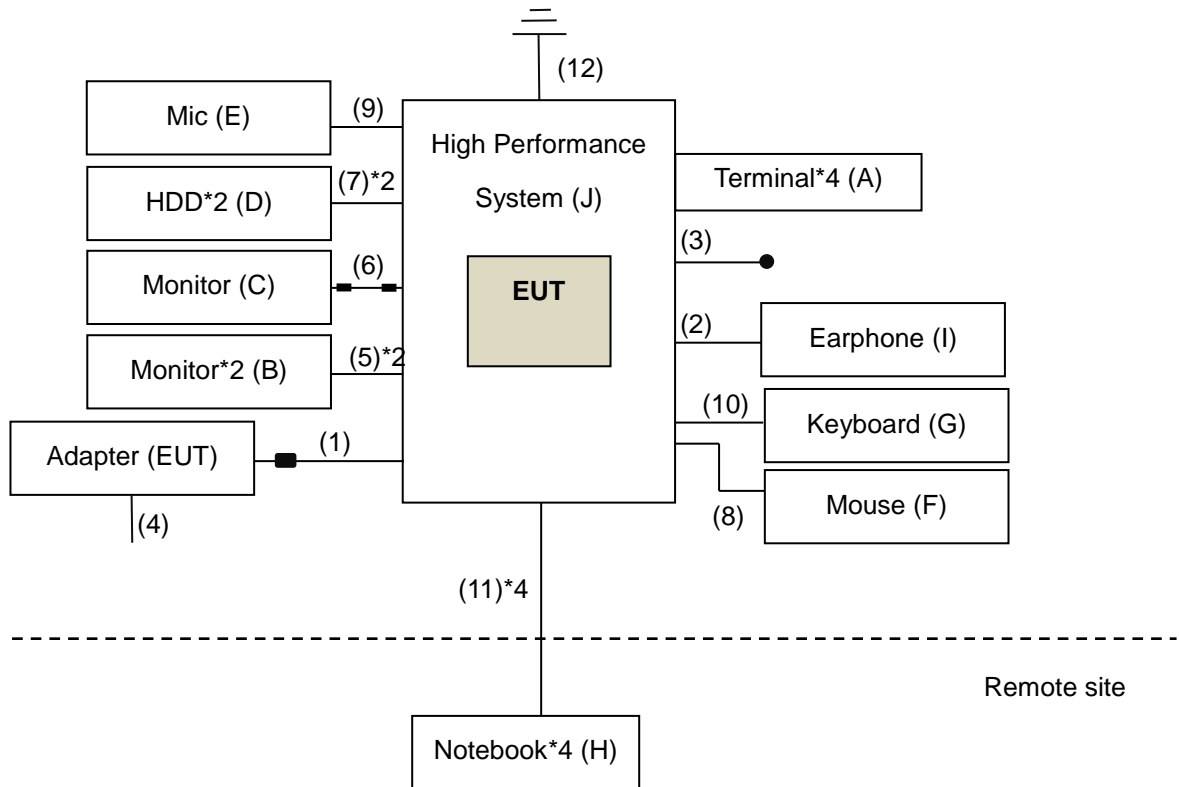

4.2 Configuration of Peripheral Devices and Cable Connections

ID	Product	Brand	Model No.	Serial No.	FCC ID	Remarks
A.	Terminal*4	N/A	N/A	N/A	N/A	Provided by client
B.	LCD Monitor	ASUS	MX27U	H3LMRS034164	N/A	--
				J3LMRS000059		
C.	LCD Monitor	DELL	U2410	CN082WXD-72872-0CR-06DL	Doc	--
D.	HDD*2	Toshiba	DTB305	45TGCNNST3ZB	N/A	--
				45U6CMTJT3ZB	N/A	--
E.	MICROPHONE	Labtec	LVA7313	N/A	N/A	--
F.	USB Mouse	DELL	MOCZUL	CN-049TWY-PRC00-79E-02FW	N/A	--
G.	USB Keyboard	Dell	KB216t	CN-0W33XP-LO300-79R-OUG6-A03	N/A	--
H.	Notebook*4	DELL	E6440	6QLNM32	N/A	--
				FMLNM32	N/A	--
				FNLNM32	N/A	--
				G4QPM32	N/A	--
I.	Earphone	PHILIPS	SBC HL150	N/A	N/A	--
J.	High Performance System	Vecow	SPC-5600A	N/A	N/A	--

Note:

1. All power cords of the above support units are non-shielded (1.8m).
2. Items H acted as communication partners to transfer data.

ID	Cable Descriptions	Qty.	Length (m)	Shielding (Yes/No)	Cores (Qty.)	Remarks
1.	DC Cable	1	1.2	N	1	Accessory of the EUT
2.	Audio Cable	1	1.2	N	0	--
3.	I/O Cable	1	0.3	N	0	Provided by client
4.	Power Cord	1	1.8	N	0	--
5.	DP Cable	1	1.8	Y	0	--
6.	DVI Cable	1	1.8	Y	2	--
7.	USB Cable	1	0.5	Y	0	--
8.	USB Cable	1	1.8	Y	0	--
9.	Audio Cable	1	1.5	N	0	--
10.	USB Cable	1	1.8	Y	0	--
11.	LAN Cable	1	10	N	0	Cat5e
12.	GND Cable	1	1.5	N	0	--

Note: The core(s)

5 Conducted Emissions at Mains Ports

5.1 Limits

Frequency (MHz)	Class A (dBuV)		Class B (dBuV)	
	Quasi-peak	Average	Quasi-peak	Average
0.15 - 0.5	79	66	66 - 56	56 - 46
0.50 - 5.0	73	60	56	46
5.0 - 30.0	73	60	60	50

Notes: 1. The lower limit shall apply at the transition frequencies.
 2. The limit decreases linearly with the logarithm of the frequency in the range of 0.15 to 0.50 MHz.

5.2 Test Instruments

Description & Manufacturer	Model No.	Serial No.	Cal. Date	Cal. Due
Test Receiver ROHDE & SCHWARZ	ESR3	102412	Feb. 14, 2019	Feb. 13, 2020
RF signal cable (with 10dB PAD) Woken	5D-FB	Cable-cond2-01	Sep. 05, 2018	Sep. 04, 2019
LISN ROHDE & SCHWARZ (EUT)	ESH2-Z5	100100	Jan. 30, 2019	Jan. 29, 2020
LISN ROHDE & SCHWARZ (Peripheral)	ESH3-Z5	100312	Aug. 13, 2018	Aug. 12, 2019
Software ADT	BV ADT_Cond_ V7.3.7.4	NA	NA	NA

Note: 1. The calibration interval of the above test instruments is 12 months and the calibrations are traceable to NML/ROC and NIST/USA.
 2. The test was performed in HwaYa Shielded Room 2.
 3. The VCCI Site Registration No. is C-12047.

5.3 Test Arrangement

- The EUT was placed 0.4 meters from the conducting wall of the shielded room with EUT being connected to the power mains through a line impedance stabilization network (LISN). Other support units were connected to the power mains through another LISN. The two LISNs provide 50 Ohm/ 50 uH of coupling impedance for the measuring instrument.
- Both lines of the power mains connected to the EUT were checked for maximum conducted interference.
- The test results of conducted emissions at mains ports are recorded of six worst margins for quasi-peak (mandatory) [and average (if necessary)] values against the limits at frequencies of interest unless the margin is 20 dB or greater.

Note: The resolution bandwidth and video bandwidth of test receiver is 9 kHz for quasi-peak detection (QP) and average detection (AV) at frequency 0.15 MHz – 30 MHz.

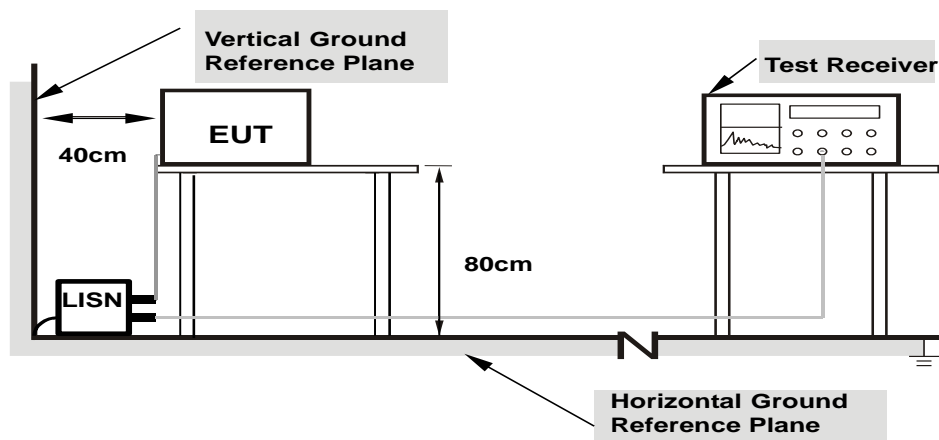

- Note:**
- Support units were connected to second LISN.
 - Both of LISNs (AMN) are 80 cm from EUT and at least 80 cm from other units and other metal planes

5.4 Test Results

Frequency Range	150kHz ~ 30MHz	Detector Function & Resolution Bandwidth	Quasi-Peak (QP) / Average (AV), 9kHz
Input Power	120Vac, 60Hz	Environmental Conditions	26°C, 72%RH
Tested by	Pon Tsai	Test Date	2019/7/23
Test Mode	Mode 1		

Phase Of Power : Line (L)										
No	Frequency (MHz)	Correction Factor (dB)	Reading Value (dBuV)		Emission Level (dBuV)		Limit (dBuV)		Margin (dB)	
			Q.P.	AV.	Q.P.	AV.	Q.P.	AV.	Q.P.	AV.
1	0.15000	10.07	31.12	24.56	41.19	34.63	79.00	66.00	-37.81	-31.37
2	0.20400	10.07	22.70	15.55	32.77	25.62	79.00	66.00	-46.23	-40.38
3	0.38260	10.07	31.95	31.24	42.02	41.31	79.00	66.00	-36.98	-24.69
4	8.79900	10.25	33.72	30.79	43.97	41.04	73.00	60.00	-29.03	-18.96
5	16.12050	10.43	27.98	19.34	38.41	29.77	73.00	60.00	-34.59	-30.23
6	21.67350	10.48	28.62	17.00	39.10	27.48	73.00	60.00	-33.90	-32.52

Remarks:

1. Q.P. and AV. are abbreviations of quasi-peak and average individually.
2. The emission levels of other frequencies were very low against the limit.
3. Margin value = Emission level – Limit value
4. Correction factor = Insertion loss + Cable loss
5. Emission Level = Correction Factor + Reading Value

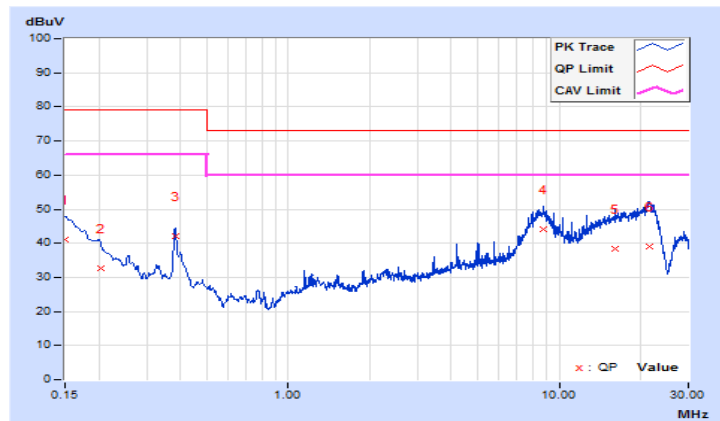

Frequency Range	150kHz ~ 30MHz	Detector Function & Resolution Bandwidth	Quasi-Peak (QP) / Average (AV), 9kHz
Input Power	120Vac, 60Hz	Environmental Conditions	26°C, 72%RH
Tested by	Pon Tsai	Test Date	2019/7/23
Test Mode	Mode 1		

Phase Of Power : Neutral (N)										
No	Frequency (MHz)	Correction Factor (dB)	Reading Value (dBuV)		Emission Level (dBuV)		Limit (dBuV)		Margin (dB)	
			Q.P.	AV.	Q.P.	AV.	Q.P.	AV.	Q.P.	AV.
1	0.15000	10.12	31.99	27.60	42.11	37.72	79.00	66.00	-36.89	-28.28
2	0.19006	10.13	26.75	17.07	36.88	27.20	79.00	66.00	-42.12	-38.80
3	0.38260	10.13	35.94	35.62	46.07	45.75	79.00	66.00	-32.93	-20.25
4	8.56050	10.35	28.79	18.42	39.14	28.77	73.00	60.00	-33.86	-31.23
5	13.73550	10.51	24.11	17.03	34.62	27.54	73.00	60.00	-38.38	-32.46
6	22.13925	10.62	25.58	14.86	36.20	25.48	73.00	60.00	-36.80	-34.52

Remarks:

1. Q.P. and AV. are abbreviations of quasi-peak and average individually.
2. The emission levels of other frequencies were very low against the limit.
3. Margin value = Emission level – Limit value
4. Correction factor = Insertion loss + Cable loss
5. Emission Level = Correction Factor + Reading Value

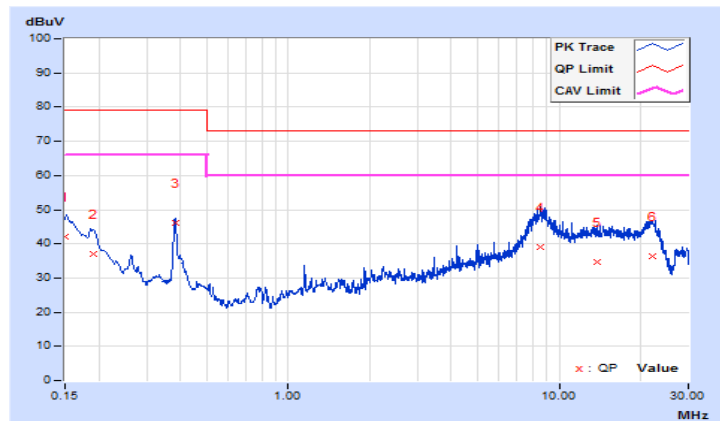

6 Radiated Emissions up to 1 GHz

6.1 Limits

Emissions radiated outside of the specified bands, shall be according to the general radiated limits as following:

Radiated Emissions Limits at 10 meters (dB μ V/m)				
Frequencies (MHz)	FCC 15B / ICES-003, Class A	FCC 15B / ICES-003, Class B	CISPR 22, Class A	CISPR 22, Class B
30-88	39	29.5	40	30
88-216	43.5	33.1		
216-230	46.4	35.6		
230-960			47	37
960-1000	49.5	43.5		

Radiated Emissions Limits at 3 meters (dB μ V/m)				
Frequencies (MHz)	FCC 15B / ICES-003, Class A	FCC 15B / ICES-003, Class B	CISPR 22, Class A	CISPR 22, Class B
30-88	49.5	40	50.5	40.5
88-216	54	43.5		
216-230	56.9	46		
230-960			57.5	47.5
960-1000	60	54		

Notes:

1. The lower limit shall apply at the transition frequencies.
2. Emission level (dB μ V/m) = 20 log Emission level (μ V/m).
3. QP detector shall be applied if not specified.

6.2 Test Instruments

Description & Manufacturer	Model No.	Serial No.	Cal. Date	Cal. Due
Test Receiver ROHDE & SCHWARZ (V)	ESR	101240	Oct. 30, 2018	Oct. 29, 2019
Test Receiver ROHDE & SCHWARZ (H)	ESR	101264	Apr. 10, 2019	Apr. 09, 2020
BILOG Antenna SCHWARZBECK (V)	VULB9168	9168-148	Nov. 20, 2018	Nov. 19, 2019
BILOG Antenna SCHWARZBECK (H)	VULB9168	9168-156	Nov. 20, 2018	Nov. 19, 2019
Preamplifier Sonoma (V)	310N	352924	Jun. 11, 2019	Jun. 10, 2020
Preamplifier Sonoma (H)	310N	352923	Jun. 11, 2019	Jun. 10, 2020
RF signal cable (with 5dB PAD) Times (V)	LMR-600 (18M) +LMR-400 (7M)	CABLE-CH1 (VER) -01	Oct. 03, 2018	Oct. 02, 2019
RF signal cable (with 5dB PAD) Times (H)	LMR-600 (11.8M) +LMR-400 (7M)	CABLE-CH1 (HOR) -01	Oct. 03, 2018	Oct. 02, 2019
Software BV ADT	BV ADT_Radiated_ V8.7.08	NA	NA	NA
Antenna Tower (V)	MFA-440	9707	NA	NA
Antenna Tower (H)	MFA-440	970705	NA	NA
Turn Table	DS430	50303	NA	NA
Controller (V)	MF7802	074	NA	NA
Controller (H)	MF7802	08093	NA	NA

NOTE: 1. The calibration interval of the above test instruments is 12 months and the calibrations are traceable to NML/ROC and NIST/USA.

2. The test was performed in HwaYa Chamber 1.

3. The VCCI Site Registration No. is R-11893.

6.3 Test Arrangement

- The EUT was placed on the top of a rotating table 0.8 meters above the ground at an accredited test facility. The table was rotated 360 degrees to determine the position of the highest radiation.
- The EUT was set 10 meters away from the interference-receiving antenna, which was mounted on the top of a variable-height antenna tower.
- The antenna is a broadband antenna, and its height is varied from one meter to four meters above the ground to determine the maximum value of the field strength. Both horizontal and vertical polarizations of the antenna are set to make the measurement.
- For each suspected emission, the EUT was arranged to its worst case and then the antenna was tuned to heights from 1 meter to 4 meters and the rotatable table was turned from 0 degrees to 360 degrees to find the maximum reading.
- The test-receiver system was set to quasi-peak detect function and specified bandwidth with maximum hold mode when the test frequency is below 1 GHz.

Note: The resolution bandwidth and video bandwidth of test receiver/spectrum analyzer is 120 kHz for quasi-peak detection (QP) at frequency below 1 GHz.

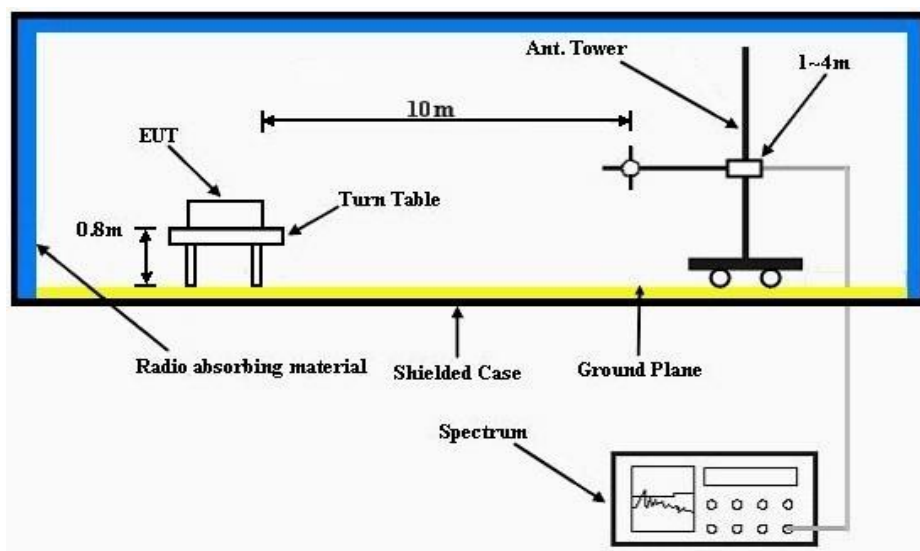

6.4 Test Results

Frequency Range	30MHz ~ 1GHz	Detector Function & Resolution Bandwidth	Quasi-Peak (QP), 120kHz
Tested by	Mick Chou	Environmental Conditions	27°C, 65%RH
Test Mode	Mode 1	Test Date	2019/7/23

Antenna Polarity & Test Distance : Horizontal at 10 m								
No	Frequency (MHz)	Emission Level (dBuV/m)	Limit (dBuV/m)	Margin (dB)	Antenna Height (m)	Table Angle (Degree)	Raw Value (dBuV)	Correction Factor (dB/m)
1	95.96	31.26 QP	40.00	-8.74	4.00 H	162	49.65	-18.39
2	239.97	40.62 QP	47.00	-6.38	4.00 H	315	54.67	-14.05
3	577.50	39.77 QP	47.00	-7.23	2.00 H	16	45.38	-5.61
4	615.99	45.27 QP	47.00	-1.73	2.00 H	50	50.06	-4.79
5	677.60	37.57 QP	47.00	-9.43	1.50 H	268	42.06	-4.49
6	770.00	36.09 QP	47.00	-10.91	2.00 H	16	39.55	-3.46

Remarks:

1. Emission Level(dBuV/m) = Raw Value(dBuV) + Correction Factor(dB/m)
2. Correction Factor(dB/m) = Antenna Factor (dB/m) + Cable Factor (dB) – Pre-Amplifier Factor (dB)
3. The other emission levels were very low against the limit.
4. Margin value = Emission level – Limit value

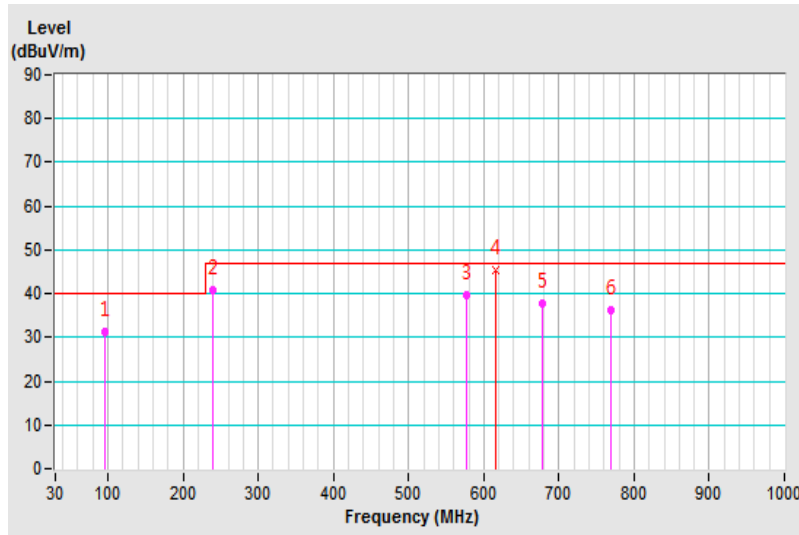

Frequency Range	30MHz ~ 1GHz	Detector Function & Resolution Bandwidth	Quasi-Peak (QP), 120kHz
Tested by	Mick Chou	Environmental Conditions	27°C, 65%RH
Test Mode	Mode 1	Test Date	2019/7/23

Antenna Polarity & Test Distance : Vertical at 10 m								
No	Frequency (MHz)	Emission Level (dBuV/m)	Limit (dBuV/m)	Margin (dB)	Antenna Height (m)	Table Angle (Degree)	Raw Value (dBuV)	Correction Factor (dB/m)
1	38.45	36.77 QP	40.00	-3.23	3.00 V	209	51.02	-14.25
2	62.74	37.01 QP	40.00	-2.99	3.50 V	188	50.99	-13.98
3	239.97	37.03 QP	47.00	-9.97	1.00 V	145	50.83	-13.80
4	462.01	33.22 QP	47.00	-13.78	1.00 V	344	40.35	-7.13
5	616.01	43.80 QP	47.00	-3.20	3.00 V	169	47.96	-4.16
6	770.00	39.27 QP	47.00	-7.73	2.00 V	149	41.43	-2.16

Remarks:

1. Emission Level(dBuV/m) = Raw Value(dBuV) + Correction Factor(dB/m)
2. Correction Factor(dB/m) = Antenna Factor (dB/m) + Cable Factor (dB) – Pre-Amplifier Factor (dB)
3. The other emission levels were very low against the limit.
4. Margin value = Emission level – Limit value

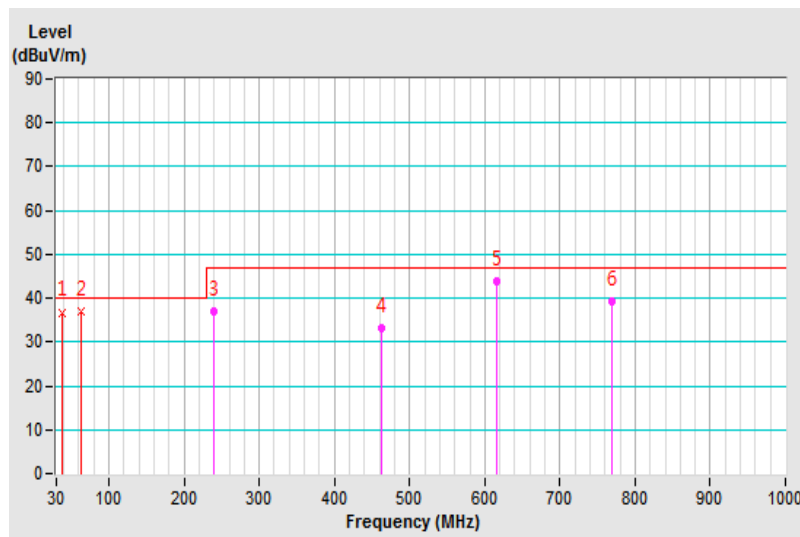

7 Radiated Emissions above 1 GHz

7.1 Limits

Emissions radiated outside of the specified bands, shall be according to the general radiated limits as following:

Radiated Emissions Limits at 10 meters (dB μ V/m)				
Frequencies (MHz)	FCC 15B / ICES-003, Class A	FCC 15B / ICES-003, Class B	CISPR 22, Class A	CISPR 22, Class B
1000-3000	Avg: 49.5	Avg: 43.5	Not defined	Not defined
Above 3000	Peak: 69.5	Peak: 63.5	Not defined	Not defined

Radiated Emissions Limits at 3 meters (dB μ V/m)				
Frequencies (MHz)	FCC 15B / ICES-003, Class A	FCC 15B / ICES-003, Class B	CISPR 22, Class A	CISPR 22, Class B
1000-3000	Avg: 60	Avg: 54	Avg: 56 Peak: 76	Avg: 50 Peak: 70
Above 3000	Peak: 80	Peak: 74	Avg: 60 Peak: 80	Avg: 54 Peak: 74

Notes:

1. The lower limit shall apply at the transition frequencies.
2. Emission level (dB μ V/m) = 20 log Emission level (uV/m).
3. As shown in 15.35(b), for frequencies above 1000 MHz, the field strength limits are based on average detector, however, the peak field strength of any emission shall not exceed the maximum permitted average limits, specified above by more than 20 dB under any condition of modulation.

Radiated Emissions Limits at 1.5 meters (dB μ V/m)		
Frequencies (MHz)	FCC 15B / ICES-003, Class A	FCC 15B / ICES-003, Class B
Above 18000	Avg: 66 Peak: 86	Avg: 60 Peak: 80

Note: Limit@1.5m = Limit@3m + 20log(3/1.5)

Frequency Range (For unintentional radiators)

Highest frequency generated or used in the device or on which the device operates or tunes (MHz)	Upper frequency of measurement range (MHz)
Below 1.705	30
1.705-108	1000
108-500	2000
500-1000	5000
Above 1000	5 th harmonic of the highest frequency or 40 GHz, whichever is lower

7.2 Test Instruments

Description & Manufacturer	Model No.	Serial No.	Cal. Date	Cal. Due
Test Receiver ROHDE & SCHWARZ (Above 1GHz)	ESR7	101471	Mar. 07, 2019	Mar. 06, 2020
Spectrum Analyzer Agilent	E4446A	MY51100039	Sep. 10, 2018	Sep. 09, 2019
RF signal cable (with 5dB PAD) Times	LMR-400 (18M)	CABLE-CH2-01	Mar. 25, 2019	Mar. 24, 2020
HORN Antenna (with 4dB PAD) SCHWARZBECK	BBHA 9120 D	9120D-405	Nov. 25, 2018	Nov. 24, 2019
Pre-Amplifier Agilent (Above 1GHz)	8449B	3008A01961	Oct. 15, 2018	Oct. 14, 2019
RF Coaxial Cable JUNFLON+EMC	JUNFLON+EMC10 4-SM-SM-6000	Cable-CH2- 02(MWX3221308G003+1307 10)	Jun. 11, 2019	Jun. 10, 2020
Software BV ADT	BV ADT_Radiated_ V8.7.08	NA	NA	NA
Antenna Tower BV ADT	AT100	AT93021702	NA	NA
Turn Table BV ADT	TT100	TT93021702	NA	NA
Controller BV ADT	SC100	SC93021702	NA	NA
RF Coaxial Cable EMCI	EMC102-KM-KM- 1000	170819	Dec. 21, 2018	Dec. 20, 2019
RF Coaxial Cable Rosnol	K1K50-UP0279- K1K50-3000	181129-1	Dec. 21, 2018	Dec. 20, 2019
Fix tool for Boresight antenna	BAF-01	2	NA	NA
Pre-amplifier (18GHz- 40GHz) EMC	EMC184045B	980175	Nov. 14, 2018	Nov. 13, 2019
HORN Antenna (with 3dB PAD) SCHWARZBECK	BBHA 9170	148	Nov. 25, 2018	Nov. 24, 2019

- Note: 1. The calibration interval of the above test instruments is 12 months and the calibrations are traceable to NML/ROC and NIST/USA.
2. The test was performed in HwaYa Chamber 2.
3. The VCCI Site Registration No. is G-10018.

7.3 Test Arrangement

- The EUT was placed on the top of a rotating table 0.8 meters above the ground at an accredited chamber room. The table was rotated 360 degrees to determine the position of the highest radiation.
- The EUT was set 3 meters away from the interference-receiving antenna, which was mounted on the top of a variable-height antenna tower.
- For frequency range 1 GHz ~ 18 GHz, the EUT was set 3 meters away from the interference-receiving antenna, which was mounted on the top of a variable-height antenna tower.
- For frequency range 18 GHz ~ 40 GHz, the EUT was set 1.5 meters away from the interference-receiving antenna, which was mounted on the top of a variable-height antenna tower.
- The height of antenna can be varied from one meter to four meters, the height of adjustment depends on the EUT height and the antenna 3 dB beamwidth both, to detect the maximum value of the field strength. Both horizontal and vertical polarizations of the antenna are set to make the measurement.
- For each suspected emission, the EUT was arranged to its worst case and then the antenna was tuned to heights and the rotatable table was turned from 0 degrees to 360 degrees to find the maximum reading.
- The spectrum analyzer system was set to peak and average detect function and specified bandwidth with maximum hold mode when the test frequency is above 1 GHz.

Note: The resolution bandwidth of test receiver/spectrum analyzer is 1 MHz and video bandwidth is 3 MHz for Peak detection (PK) at frequency above 1 GHz. The resolution bandwidth of test receiver/spectrum analyzer is 1 MHz for Average detection (AV) at frequency above 1 GHz.

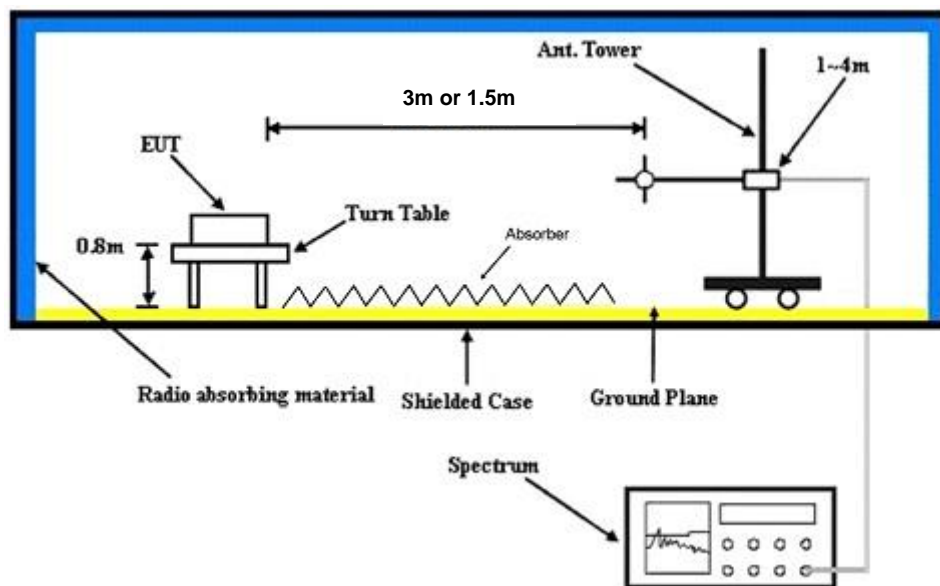

7.4 Test Results

Frequency Range	1GHz ~ 18GHz	Detector Function & Resolution Bandwidth	Peak (PK) / Average (AV), 1MHz
Tested by	James Chang	Environmental Conditions	26°C, 70%RH
Test Mode	Mode 1	Test Date	2019/7/24

Antenna Polarity & Test Distance : Horizontal at 3 m								
No	Frequency (MHz)	Emission Level (dBuV/m)	Limit (dBuV/m)	Margin (dB)	Antenna Height (m)	Table Angle (Degree)	Raw Value (dBuV)	Correction Factor (dB/m)
1	1386.01	58.60 PK	80.00	-21.40	1.12 H	186	59.92	-1.32
2	1386.01	50.95 AV	60.00	-9.05	1.12 H	186	52.27	-1.32
3	1539.95	60.48 PK	80.00	-19.52	1.01 H	220	62.03	-1.55
4	1539.95	50.34 AV	60.00	-9.66	1.01 H	220	51.89	-1.55
5	2002.01	56.94 PK	80.00	-23.06	1.35 H	144	56.75	0.19
6	2002.01	47.74 AV	60.00	-12.26	1.35 H	144	47.55	0.19

Remarks:

1. Emission Level(dBuV/m) = Raw Value(dBuV) + Correction Factor(dB/m)
2. Correction Factor(dB/m) = Antenna Factor (dB/m) + Cable Factor (dB) – Pre-Amplifier Factor (dB)
3. The other emission levels were very low against the limit.
4. Margin value = Emission level – Limit value

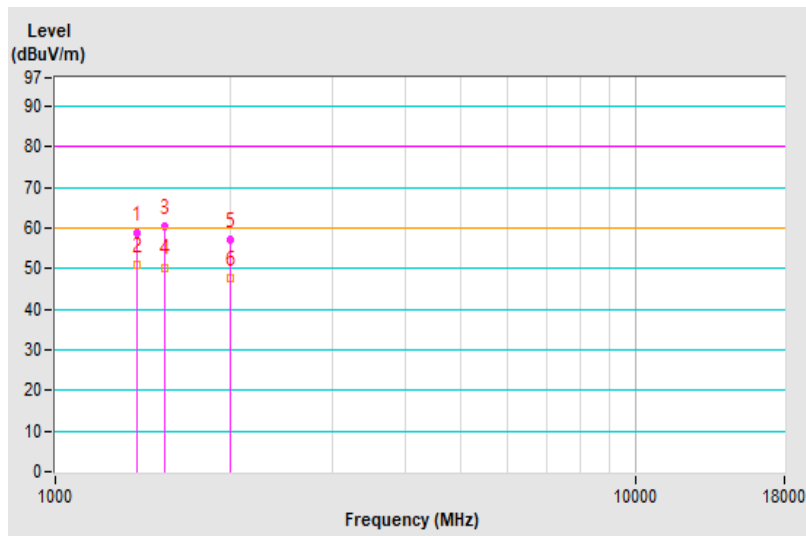

Frequency Range	1GHz ~ 18GHz	Detector Function & Resolution Bandwidth	Peak (PK) / Average (AV), 1MHz
Tested by	James Chang	Environmental Conditions	26°C, 70%RH
Test Mode	Mode 1	Test Date	2019/7/24

Antenna Polarity & Test Distance : Vertical at 3 m								
No	Frequency (MHz)	Emission Level (dBuV/m)	Limit (dBuV/m)	Margin (dB)	Antenna Height (m)	Table Angle (Degree)	Raw Value (dBuV)	Correction Factor (dB/m)
1	1386.03	56.77 PK	80.00	-23.23	1.21 V	157	58.09	-1.32
2	1386.03	49.80 AV	60.00	-10.20	1.21 V	157	51.12	-1.32
3	2002.01	57.78 PK	80.00	-22.22	1.10 V	169	57.59	0.19
4	2002.01	50.02 AV	60.00	-9.98	1.10 V	169	49.83	0.19
5	2309.98	49.16 PK	80.00	-30.84	1.41 V	156	47.75	1.41
6	2309.98	46.01 AV	60.00	-13.99	1.41 V	156	44.60	1.41

Remarks:

1. Emission Level(dBuV/m) = Raw Value(dBuV) + Correction Factor(dB/m)
2. Correction Factor(dB/m) = Antenna Factor (dB/m) + Cable Factor (dB) – Pre-Amplifier Factor (dB)
3. The other emission levels were very low against the limit.
4. Margin value = Emission level – Limit value

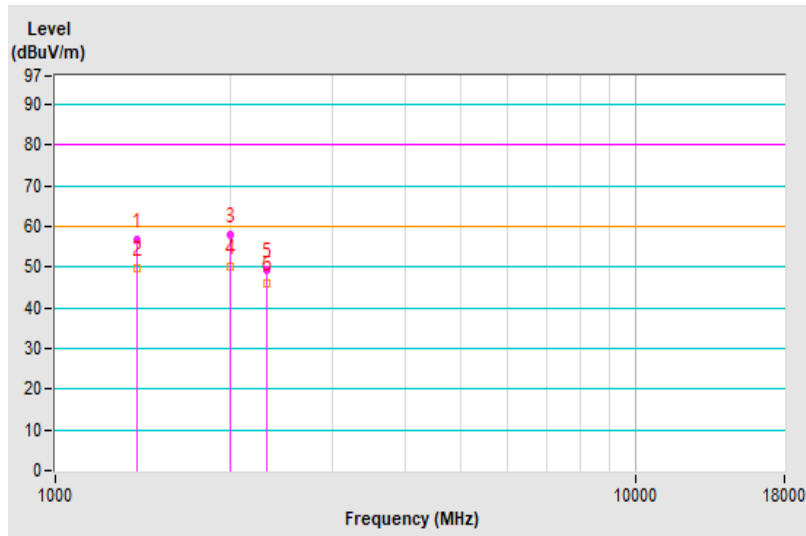

Frequency Range	18GHz ~ 26GHz	Detector Function & Resolution Bandwidth	Peak (PK) / Average (AV), 1MHz
Tested by	James Chang	Environmental Conditions	26°C, 70%RH
Test Mode	Mode 1	Test Date	2019/7/24

Antenna Polarity & Test Distance : Horizontal at 1.5 m								
No	Frequency (MHz)	Emission Level (dBuV/m)	Limit (dBuV/m)	Margin (dB)	Antenna Height (m)	Table Angle (Degree)	Raw Value (dBuV)	Correction Factor (dB/m)
1	18281.28	72.23 PK	86.00	-13.77	1.39 H	313	72.23	0.00
2	18281.28	47.03 AV	66.00	-18.97	1.39 H	313	47.03	0.00

Remarks:

1. Emission Level(dBuV/m) = Raw Value(dBuV) + Correction Factor(dB/m)
2. Correction Factor(dB/m) = Antenna Factor (dB/m) + Cable Factor (dB) – Pre-Amplifier Factor (dB)
3. The other emission levels were very low against the limit.
4. Margin value = Emission level – Limit value

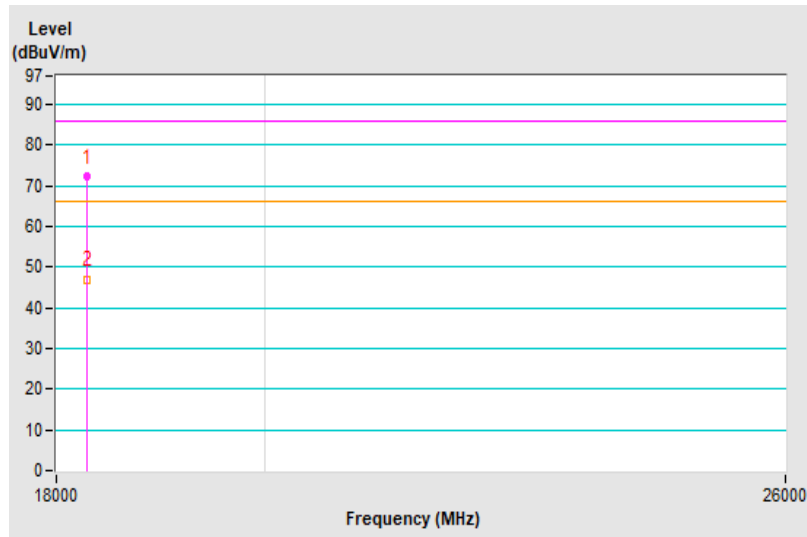

Frequency Range	18GHz ~ 26GHz	Detector Function & Resolution Bandwidth	Peak (PK) / Average (AV), 1MHz
Tested by	James Chang	Environmental Conditions	26°C, 70%RH
Test Mode	Mode 1	Test Date	2019/7/24

Antenna Polarity & Test Distance : Vertical at 1.5 m								
No	Frequency (MHz)	Emission Level (dBuV/m)	Limit (dBuV/m)	Margin (dB)	Antenna Height (m)	Table Angle (Degree)	Raw Value (dBuV)	Correction Factor (dB/m)
1	18480.53	71.27 PK	86.00	-14.73	1.08 V	291	71.27	0.00
2	18480.53	45.34 AV	66.00	-20.66	1.08 V	291	45.34	0.00

Remarks:

1. Emission Level(dBuV/m) = Raw Value(dBuV) + Correction Factor(dB/m)
2. Correction Factor(dB/m) = Antenna Factor (dB/m) + Cable Factor (dB) – Pre-Amplifier Factor (dB)
3. The other emission levels were very low against the limit.
4. Margin value = Emission level – Limit value

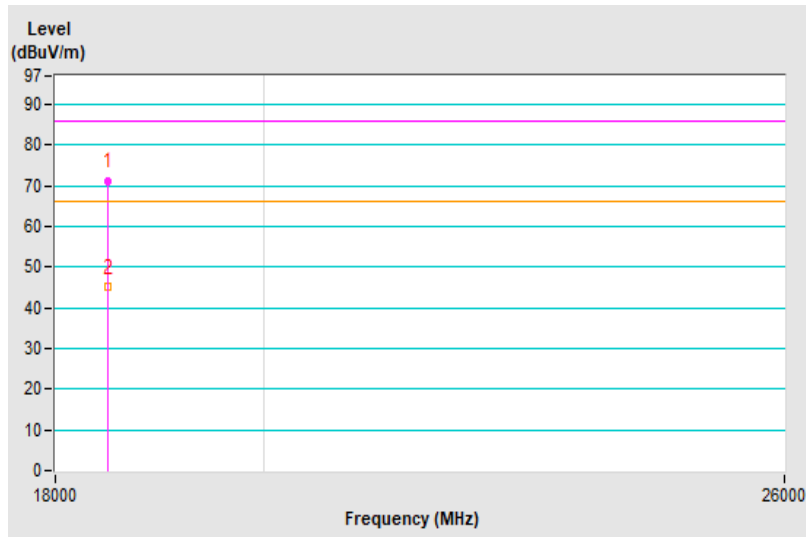

8 Pictures of Test Arrangements

8.1 Conducted Emissions at Mains Ports

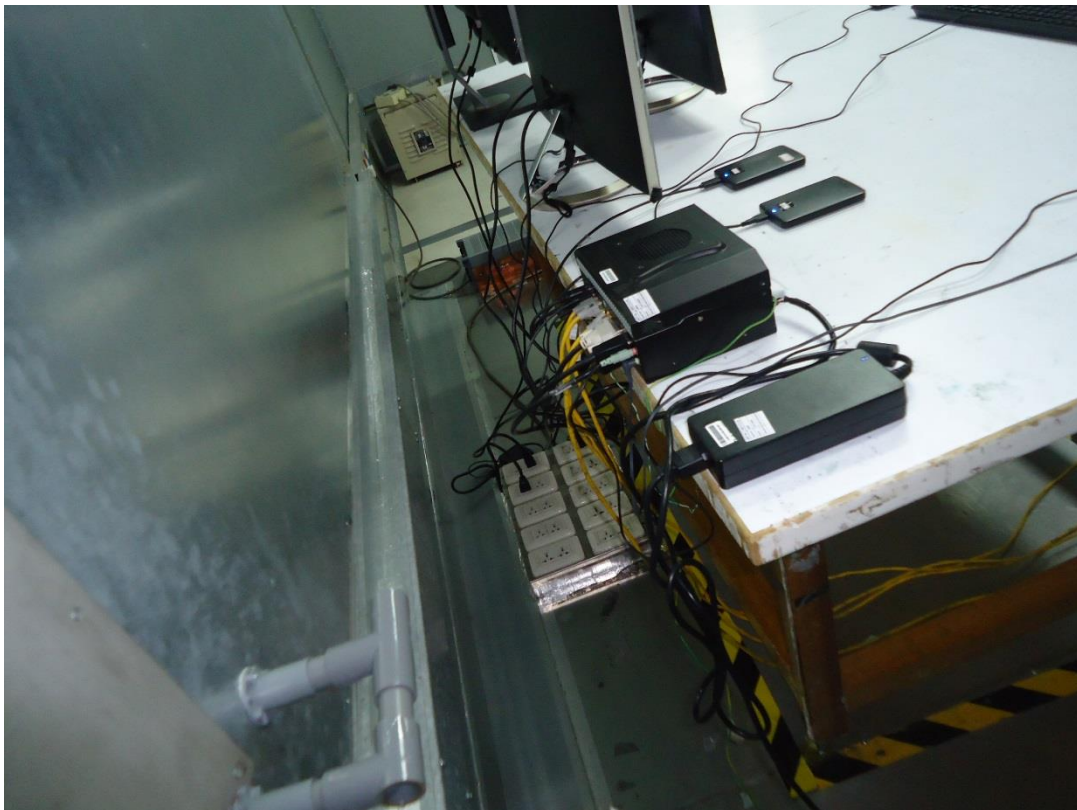

8.2 Radiated Emissions up to 1 GHz



8.3 Radiated Emissions above 1 GHz

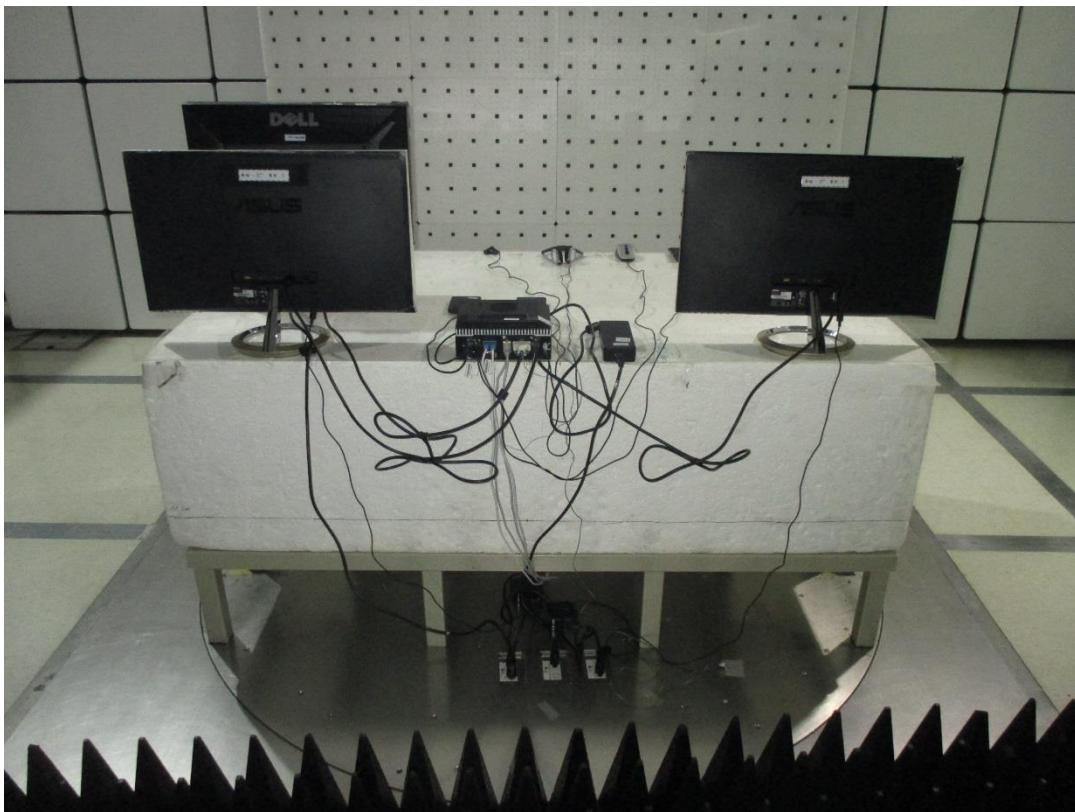

Appendix – Information of the Testing Laboratories

We, Bureau Veritas Consumer Products Services (H.K.) Ltd., Taoyuan Branch, were founded in 1988 to provide our best service in EMC, Radio, Telecom and Safety consultation. Our laboratories are FCC recognized accredited test firms and accredited according to ISO/IEC 17025.

If you have any comments, please feel free to contact us at the following:

Lin Kou EMC/RF Lab

Tel: 886-2-26052180

Fax: 886-2-26051924

Hsin Chu EMC/RF/Telecom Lab

Tel: 886-3-6668565

Fax: 886-3-6668323

Hwa Ya EMC/RF/Safety Lab

Tel: 886-3-3183232

Fax: 886-3-3270892

Email: service.adt@tw.bureauveritas.com

Web Site: www.bureauveritas-adt.com

The address and road map of all our labs can be found in our web site also.

--- END ---